

CATALOG - FE - Hırdavatçı aksesuarları

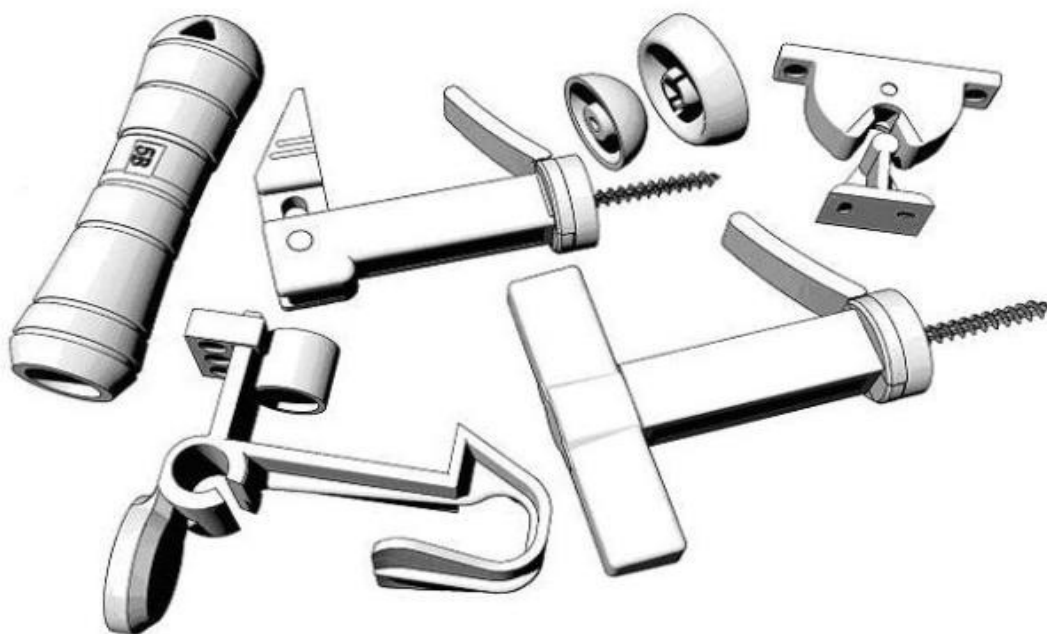

Endeksi (katalogda görünüm sirasına göre):

- El aletleri sapları
- Kapı stopları
- Panjur tutucuları
- Aksesuarlar

The measures and weights indicated in the catalogue are nominal values.

The descriptions between equals (=) are special versions without immediate availability on stock.

Discard up to a 1% is to be considered normal.

[Hırdavatçı aksesuarları](#) / [El aletleri sapları](#)

POSITION KOD	DESCRIPTION	MATERIAL	COLOR ÜSTYÜZEY	PACKAGING AMBALAJ
01.a FEU200B000/00NO	Tool handle – B -, with conical holed bushing from 2 to 6 mm	polyethylene	walnut -	20 x box -

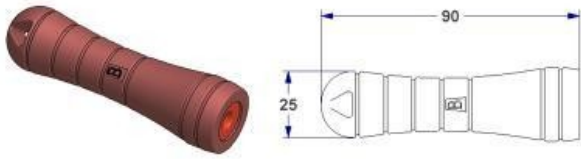

POSITION KOD	DESCRIPTION	MATERIAL	COLOR ÜSTYÜZEY	PACKAGING AMBALAJ
02.a FEU200B100/00NO	Tool handle – B1 -, with conical holed bushing from 2 to 4 mm	polyethylene	walnut -	20 x box -

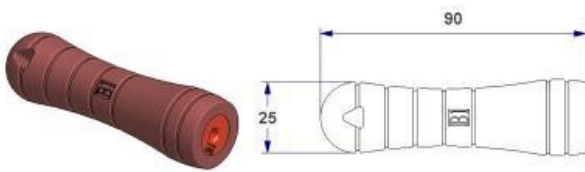

POSITION KOD	DESCRIPTION	MATERIAL	COLOR ÜSTYÜZEY	PACKAGING AMBALAJ
03.a FEU200C000/00NO	Tool handle – C -, with conical holed bushing from 3 to 7 mm	polyethylene	walnut -	50 x box -

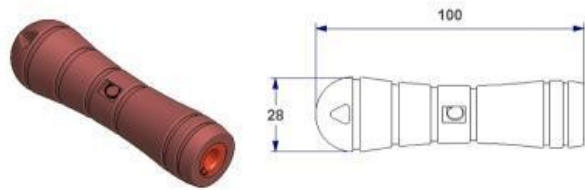

POSITION KOD	DESCRIPTION	MATERIAL	COLOR ÜSTYÜZEY	PACKAGING AMBALAJ
04.a FEU200C100/00NO	Tool handle – C1 -, with conical holed bushing from 2 to 6 mm	polyethylene	walnut -	50 x box -

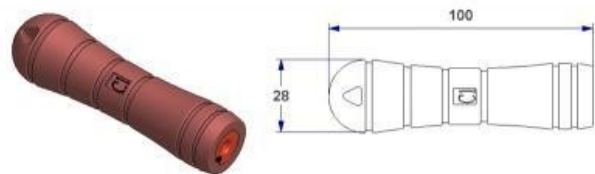

POSITION KOD	DESCRIPTION	MATERIAL	COLOR ÜSTYÜZEY	PACKAGING AMBALAJ
05.a FEU200D000/00NO	Tool handle – D -, with conical holed bushing from 4 to 8 mm	polyethylene	walnut -	40 x box -

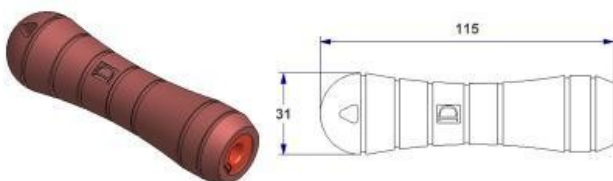

 [Hırdavatçı aksesuarları](#) / [El aletleri sapları](#)

POSITION KOD	DESCRIPTION	MATERIAL	COLOR ÜSTYÜZEY	PACKAGING AMBALAJ
06.a FEU200E000/00NO	Tool handle – E -, with conical holed bushing from 5 to 9 mm	polyethylene	walnut -	30 x box -

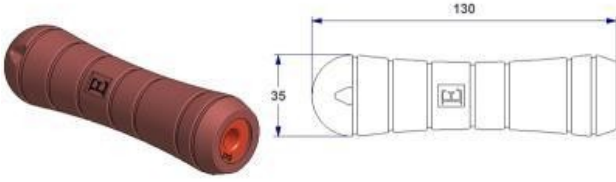

POSITION KOD	DESCRIPTION	MATERIAL	COLOR ÜSTYÜZEY	PACKAGING AMBALAJ
07.a FEU2010000/00NO	Tool handle - 1 -, with self-tapping bushing hole M4 - M5	çelik polyethylene	walnut -	20 x box -

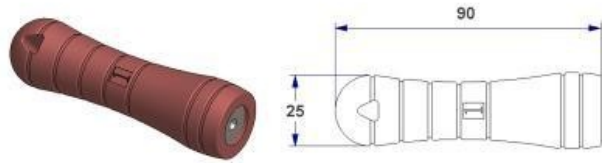

The steel bush has been carbonitrided in order to increase its superficial hardness

POSITION KOD	DESCRIPTION	MATERIAL	COLOR ÜSTYÜZEY	PACKAGING AMBALAJ
08.a FEU2020000/00NO	Tool handle - 2 -, with self-tapping bushing hole M5 - M6	çelik polyethylene	walnut -	20 x box -

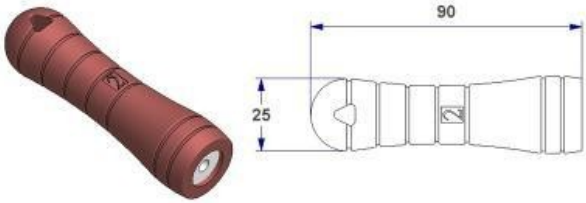

The steel bush has been carbonitrided in order to increase its superficial hardness

POSITION KOD	DESCRIPTION	MATERIAL	COLOR ÜSTYÜZEY	PACKAGING AMBALAJ
09.a FEU2030000/00NO	Tool handle - 3 -, with self-tapping bushing hole M6 - M8	çelik polyethylene	walnut -	50 x box -

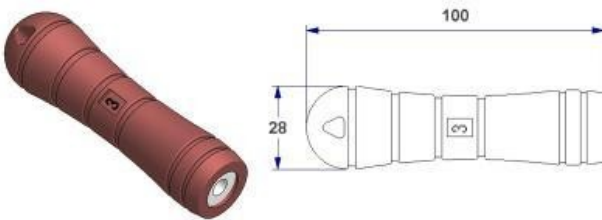

The steel bush has been carbonitrided in order to increase its superficial hardness

POSITION KOD	DESCRIPTION	MATERIAL	COLOR ÜSTYÜZEY	PACKAGING AMBALAJ
10.a FEU2040000/00NO	Tool handle - 4 -, with self-tapping bushing hole M8 - M10	çelik polyethylene	walnut -	50 x box -

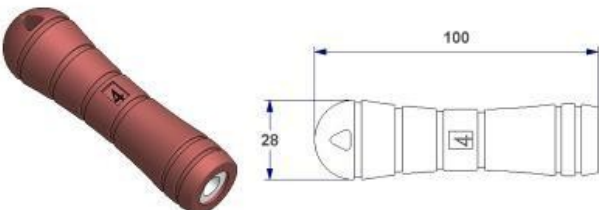

The steel bush has been carbonitrided in order to increase its superficial hardness

 [Hırdavatçı aksesuarları](#) / [El aletleri sapları](#)

POSITION KOD	DESCRIPTION	MATERIAL	COLOR ÜSTYÜZEY	PACKAGING AMBALAJ
11.a FEU204B000/00NO	Tool handle - 4B -, with self-tapping bushing hole M8 - M10	çelik polyethylene	walnut -	40 x box -

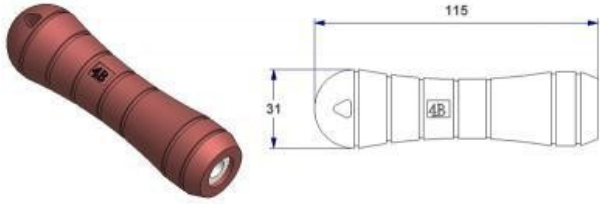

The steel bush has been carbonitrided in order to increase its superficial hardness

POSITION KOD	DESCRIPTION	MATERIAL	COLOR ÜSTYÜZEY	PACKAGING AMBALAJ
12.a FEU205A000/00NO	Tool handle - 5A -, with self-tapping bushing hole M10 - M12	çelik polyethylene	walnut -	40 x box -

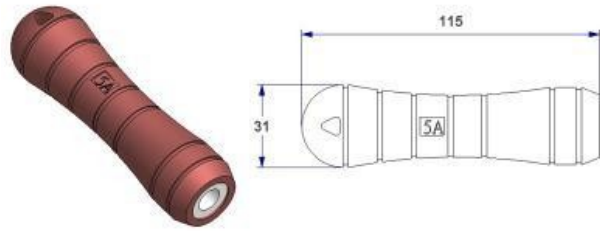

The steel bush has been carbonitrided in order to increase its superficial hardness

POSITION KOD	DESCRIPTION	MATERIAL	COLOR ÜSTYÜZEY	PACKAGING AMBALAJ
13.a FEU205B000/00NO	Tool handle - 5B -, with self-tapping bushing hole M10 - M12	çelik polyethylene	walnut -	30 x box -

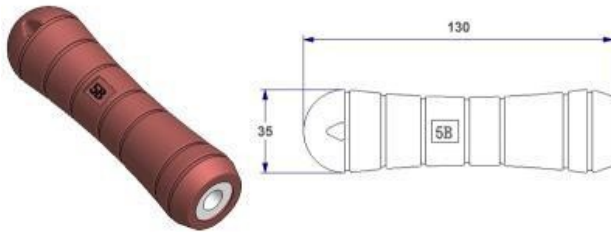

The steel bush has been carbonitrided in order to increase its superficial hardness

POSITION KOD	DESCRIPTION	MATERIAL	COLOR ÜSTYÜZEY	PACKAGING AMBALAJ
15.a FEU2080000/00NO	Tool handle - 8 -, with self-tapping bushing hole M14 - M16	iron polyethylene	walnut -	30 x box -

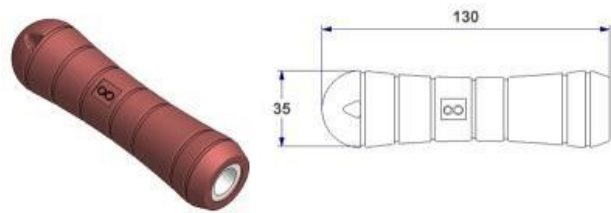

[Hırdavatçı aksesuarları](#) / [Kapı stopları](#)

POSITION KOD	DESCRIPTION	MATERIAL	COLOR ÜSTYÜZEY	PACKAGING AMBALAJ
16.a FES2510000/00BA	=Door-stop clip with floor and wall junction with mounting screws and plugs=	polyacetal	white -	50 x box 500
16.d FES2510000/00AG	=Door-stop clip with floor and wall junction with mounting screws and plugs=	polyacetal	silver -	50 x box 500

OLD MODEL

Available while supplies last

Release weight 6,5 kg



POSITION KOD	DESCRIPTION	MATERIAL	COLOR ÜSTYÜZEY	PACKAGING AMBALAJ
16.m FES251B000/00NA	Door-stop clip PIRANHA with floor and wall junction with mounting screws and plugs	polyacetal	black -	50 x box 500
16.s FES251B000L00NA	Door-stop clip PIRANHA with floor and wall junction without mounting screws and plugs	polyacetal	black -	- 1.000

Release weight 6,5 kg



POSITION KOD	DESCRIPTION	MATERIAL	COLOR ÜSTYÜZEY	PACKAGING AMBALAJ
17.a FES2520000/00NA	Door-stop clip with floor and wall junction with mounting screws and plugs	polyacetal	black -	50 x box 500



POSITION KOD	DESCRIPTION	MATERIAL	COLOR ÜSTYÜZEY	PACKAGING AMBALAJ
17.b FES2530000L00BA	=Round door stop clip=	polyamide	white -	1.000 x bag -
17.b.01 FES2530000L00NA	Round door stop clip	polyamide	black -	1.000 x bag -

= = : see details



[Hırdavatçı aksesuarları](#) / [Kapı stopları](#)

POSITION KOD	DESCRIPTION	MATERIAL	COLOR ÜSTYÜZEY	PACKAGING AMBALAJ
17.c FES253S000L00BA	=Spacers 10 mm, for round door stops=	polyamide	white -	1.000 x bag -
17.c.01 FES253S000L00NA	Spacers 10 mm, for round door stops	polyamide	black -	1.000 x bag -



= = : see details

 [Hırdavatçı aksesuarları](#) / [Panjur tutucuları](#)

POSITION KOD	DESCRIPTION	MATERIAL	COLOR ÜSTYÜZEY	PACKAGING AMBALAJ
18.a FES257B000/00NA	Shutter stay with tilt head, flexible damper, screw and plug for fixation, for shutters from 44 to 65 mm	iron polyamide	black -	30 x box 300
18.b FES257B000/00OC	=Shutter stay with tilt head, flexible damper, screw and plug for fixation, for shutters from 44 to 65 mm=	iron polyamide	light gold -	30 x box 300
18.c FES257B000/00AG	=Shutter stay with tilt head, flexible damper, screw and plug for fixation, for shutters from 44 to 65 mm=	iron polyamide	silver -	30 x box 300
18.d FES257B000D00NA	Shutter stay with tilt head, flexible damper, screw and plug for fixation, for shutters from 44 to 65 mm	iron polyamide	black -	- 350

== : see details

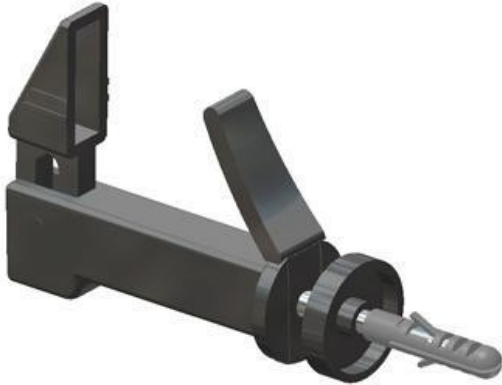

POSITION KOD	DESCRIPTION	MATERIAL	COLOR ÜSTYÜZEY	PACKAGING AMBALAJ
19.a FES2590000/00NA	Butterfly shutter holder, with damping spacer, screw and fixing plug, for shutters from 51 to 58 mm	iron polyamide	black -	25 x box 250
19.b FES2590000C00NA	Butterfly shutter holder, with damping spacer, screw and fixing plug, for shutters from 51 to 58 mm	iron polyamide	black -	- 300



[Hırdavatçı aksesuarları](#) / [Panjur tutucuları](#)

POSITION KOD	DESCRIPTION	MATERIAL	COLOR ÜSTYÜZEY	PACKAGING AMBALAJ
20.a FES259B000/00NA	Butterfly shutter holder, with flexible damper, screw and fixing plug, for shutters from 44 to 65 mm	iron polyamide	black -	25 x box 250
20.b FES259B000/00OC	=Butterfly shutter holder, with flexible damper, screw and fixing plug, for shutters from 44 to 65 mm=	iron polyamide	light gold -	25 x box 250
20.c FES259B000/00AG	=Butterfly shutter holder, with flexible damper, screw and fixing plug, for shutters from 44 to 65 mm=	iron polyamide	silver -	25 x box 250
20.d FES259B000C00NA	Butterfly shutter holder, with flexible damper, screw and fixing plug, for shutters from 44 to 65 mm	iron polyamide	black -	- 300

== : see details



POSITION KOD	DESCRIPTION	MATERIAL	COLOR ÜSTYÜZEY	PACKAGING AMBALAJ
20.g FES2600000/01NA	Automatic shutter holder TORNADO, with screw d 6x60 mm and plug for fixation, with distance pieces for shutters from 39 to 56 mm	iron SBS polyacetal	black -	10 x box 100

Provided with screw and plug

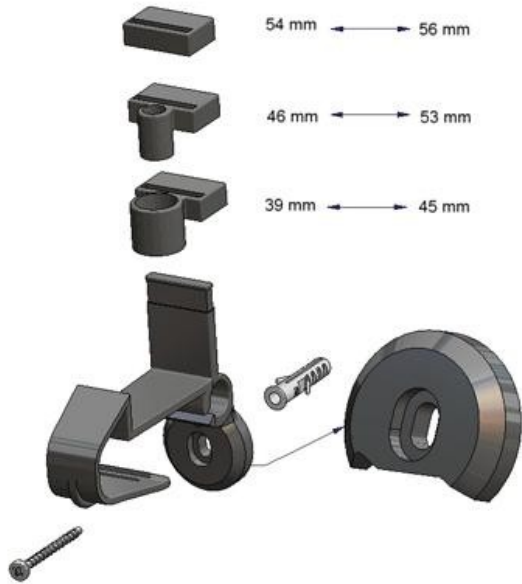

[Hırdavatçı aksesuarları](#) / [Panjur tutucuları](#)

POSITION KOD	DESCRIPTION	MATERIAL	COLOR ÜSTYÜZEY	PACKAGING AMBALAJ
20.h FES2600000/02NA	=Automatic shutter holder TORNADO, with screw d 6x60 mm and plug for fixation, with distance pieces for shutters from 12 to 38 mm=	iron SBS polyacetal	black -	10 x box 100

= = : see details
Provided with screw and plug

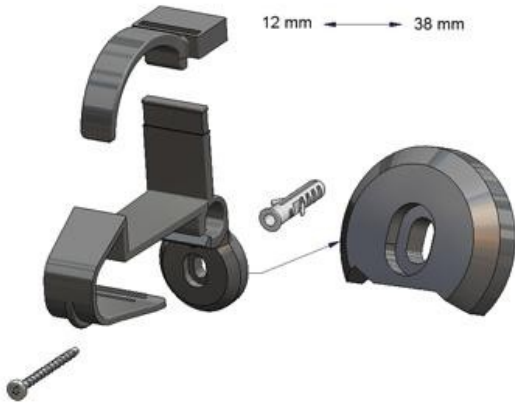

POSITION KOD	DESCRIPTION	MATERIAL	COLOR ÜSTYÜZEY	PACKAGING AMBALAJ
20.q FES2600000F01NA	Automatic shutter holder TORNADO, for screw d 7 mm, with distance pieces for shutters from 39 to 56 mm	iron SBS polyacetal	black -	- 150

Without screw and plug

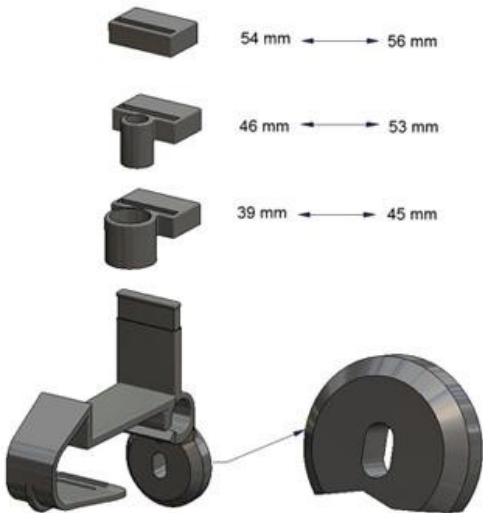

POSITION KOD	DESCRIPTION	MATERIAL	COLOR ÜSTYÜZEY	PACKAGING AMBALAJ
20.r FES2600000F02NA	=Automatic shutter holder TORNADO, for screw d 7 mm, with distance pieces for shutters from 12 to 38 mm=	iron SBS polyacetal	black -	- 150

= = : see details
Without screw and plug



 [Hırdavatçı aksesuarları](#) / Aksesuarlar

POSITION KOD	DESCRIPTION	MATERIAL	COLOR ÜSTYÜZEY	PACKAGING AMBALAJ
21.a MAZ0540000/00BR	=Knob for shutter stay=	SBS	gold bronze -	5.000 x bag -
21.b MAZ0540000/00NA	Knob for shutter stay	SBS	black -	5.000 x bag -

= = : see details



POSITION KOD	DESCRIPTION	MATERIAL	COLOR ÜSTYÜZEY	PACKAGING AMBALAJ
22.a MAZ1618000/0002	Door handle protection ring with internal d 16 and 18 mm	polyvinyl chloride	transparent -	100 x bag 1.500

Article not produced by atp

